

# G-SEAL™

by GREENSTREAK PATENT NO. 5,375,386

**SAY "NO"**  
to  
traditional  
joint sealing  
products

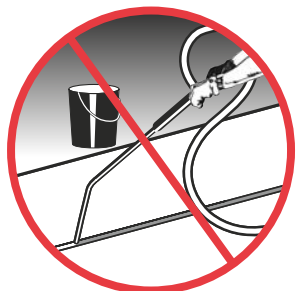

**Hot Poured**



**Cold Poured**

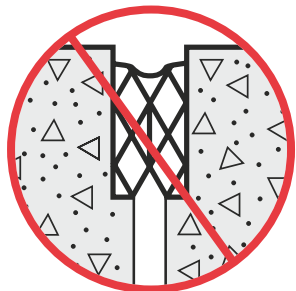

**Compression Seal**

And say **"YES"** to **G-SEAL**  
wherever you place concrete



- Cost effective alternative to joint sealants
- Maintenance free, long lasting joint seal
- Accommodates joint movement without failure
- Installs easily at any temperature or climate



Phone (800) 325-9504 or (636) 225-9400

**GREENSTREAK®**

## COST BENEFITS

- Requires no mobilization
- Installation schedule is predictable
- Requires no return visit after concrete finishing
- Competitively priced with traditional joint sealing products
- Durability reduces maintenance cost

## DURABILITY AND APPEARANCE

- Acts similar to a waterstop
- Will not work free from joint
- Formulated for resistance to normally encountered chemicals (consult Greenstreak for special formulations)
- Excellent abrasion resistance
- Available in a variety of colors for decorative concrete

## PHYSICAL PROPERTIES

PROPERTY	TEST METHOD	REQUIREMENTS	TYPICAL PROPERTIES OF G-SEAL
Tensile Strength	ASTM D412-92	2350 psi	2470 psi
Elongation	ASTM D412-92	375% min.	410%
Hardness	ASTM D2240-95	81 +/- 3 Shore A	81 Shore A
Oil Swell ASTM#3 Oil, 70 hrs. @ 212°F Change in Volume/Weight	ASTM D471-95	+/-3 % by volume +/-15% by weight	1.74% by volume -10.1 by weight
Abrasion Resistance (10,500 cycles, 1000 gram load)	ASTM D3884	Material Loss - 0.35 gms. max.	Material Loss - 0.26 gms.
Ozone Resistance (20% strain, 300pphm, 70 hrs @ 104°F)	ASTM D518-91	No Cracking	No Cracking
Adhesive Bond Strength	ASTM D412-92	1000 psi min.	1098 psi
Results after Heat Aging (24hrs. @ 70°C)	ASTM D573	Tensile Strength Retained - 90% Elongation Retained - 90% Hardness change in points +/- 3	Tensile Strength Retained - 99% Elongation Retained 98% Hardness change in points 0

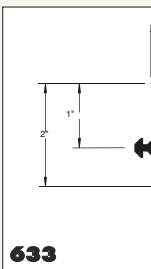
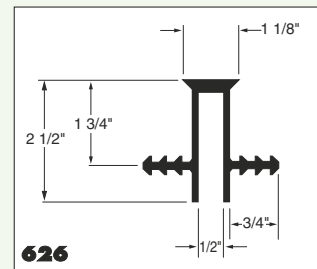
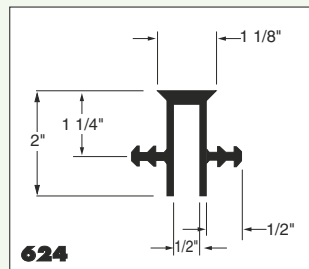
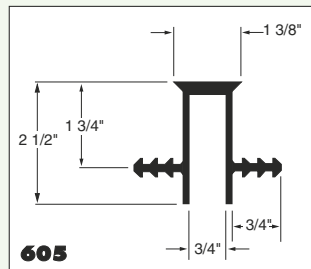
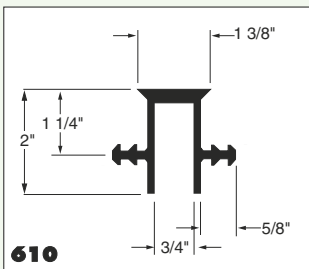

CALL GREENSTREAK'S TECHNICAL SERVICE DEPARTMENT FOR ASSISTANCE WITH MATERIAL

# G-SEAL™

by GREENSTREAK PATENT NO. 5,375,386

## INSTALLATION BENEFITS

- Creates an aesthetically pleasing concrete joint
- Compatible with all types of expansion boards
- Requires no special tools or equipment
- Installs easily prior to placement of concrete
- Allows for uninterrupted concrete placement
- Requires no tooling of joint
- Installs at any temperature and climatic condition
- Factory fabrications simplify intersections and transitions
- Offers flexibility for radius joint positioning
- Installs safely and is non-toxic
- Creates maintenance free, long lasting joint seal

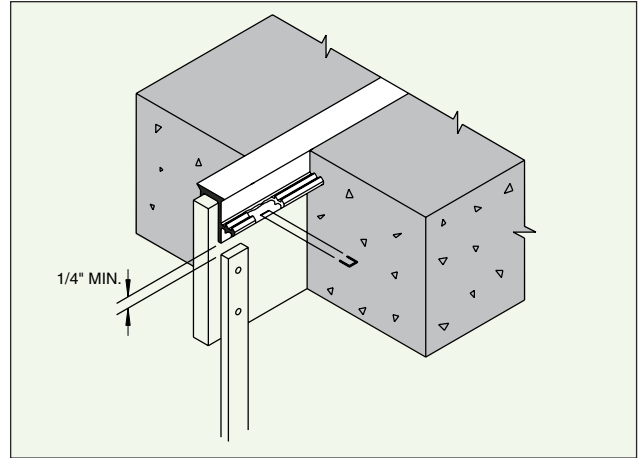

## INSTALLATION



- Leave a 1/4" minimum clearance from the top of the stake to the bottom edge of **G-SEAL**.
- Place **G-SEAL** over the expansion board and secure with staples or nails along the lower flange.
- Place concrete using normal practices and screed evenly with the top of **G-SEAL**.
- Bullfloat concrete using normal practices.



- Apply **G-SEAL ADHESIVE** when making straight splices.
- Install Factory Fabricated **G-SEAL** Ells, Tees and Crosses at intersections and transitions.
- Install **G-SEAL RETRO-FIT** in areas with existing concrete.
- Install **G-SEAL SCREED CAP** over metal screed in longitudinal joints.

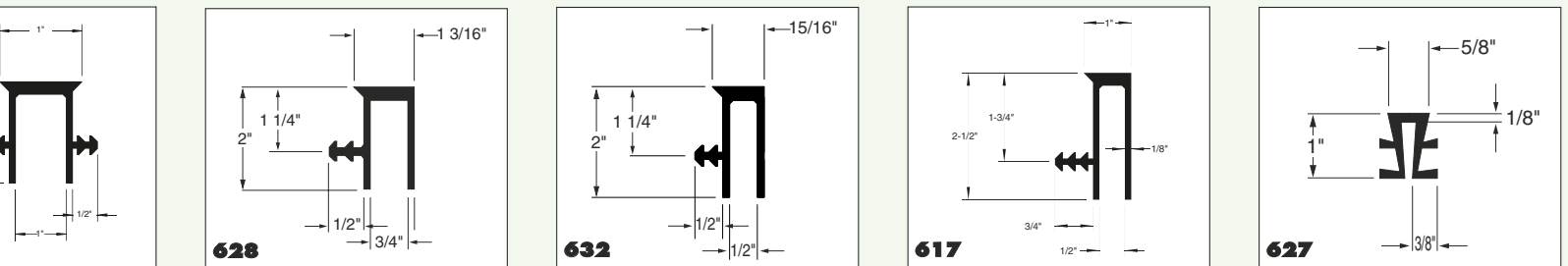

TYPE AND DESIGN SELECTION (800) 325-9504

**GREENSTREAK**®

## PACKAGING

All G-SEAL profiles are manufactured in standard lengths of 10 feet. Consult Greenstreak for applications requiring special lengths.

## SPECIFICATION

### 1) MATERIALS

- A. Provide flexible, modified PVC (polyvinyl chloride) "G-SEAL" as manufactured by Greenstreak, profile style number (fill in profile style number).
- B. The modified PVC paving cap seal shall be extruded from an elastomeric plastic material of which the basic resins are prime virgin materials. The compound shall not contain any scrapped or reclaimed material whatsoever.
- C. Performance Requirements shall follow those listed in the table on page two of this product catalog.
- D. The specific profile style chosen shall weigh a minimum of 0.50 pounds per lineal foot.
- E. The profile shall have a minimum of two fins on the embedded legs for the purpose of anchorage and creating a waterstop.



### 2) ACCESSORIES

- A. Provide factory made fabrications for all changes of direction, intersections, and transitions leaving only straight butt joint splices for field assembly.
- B. Provide Greenstreak "G-SEAL" Adhesive for sealing of all butt splices.

### 3) INSTALLATION

- A. Field butt splices shall be sealed using Greenstreak G-SEAL Adhesive.
- B. G-SEAL shall be attached to expansion board prior to concrete placement, using staples or nails driven through bottom flange area of G-SEAL profile.

**LIMITED WARRANTY:** GREENSTREAK warrants to the Buyer that this product will be free of defects and will perform as represented in writing subject to the following (2) conditions:

First, the application of the product and the concrete construction practices used in the application are in accordance with GREENSTREAK'S recommendations.

Second, the Buyer has selected the proper product for the specific application required. GREENSTREAK disclaims any responsibility for the selection of a particular **G-SEAL** product.

Product selection is the sole responsibility and decision of the buyer. The suitability of any material for a specific application requiring fluid resistance is best determined by specific testing for the application. GREENSTREAK urges the Buyer to conduct its own testing.

Any information supplied by GREENSTREAK with respect to its products is believed to be correct. GREENSTREAK makes no representations or warranties, express or implied, as to the accuracy or completeness of such information or the use of such information for a particular purpose. GREENSTREAK has not performed any tests. Any test data has been prepared by independent commercial laboratories.

Because GREENSTREAK has no control over either the application or the selection of its products, GREENSTREAK'S Limited Warranty is as follows:

The exclusive remedies of the Buyer and the limit of the liability of GREENSTREAK from any and all losses or damages resulting from the use of this product (including claims based on contract, negligence, strict liability, or otherwise) shall be either the full refund of the purchase price to Buyer of this product or the replacement of the quantity of product purchased by the Buyer—at the election of GREENSTREAK. In no event shall GREENSTREAK be liable for any incidental or consequential damages. The Buyer and all users of this product are deemed to have accepted the terms of this Limited Warranty which may not be varied in any way by any verbal or written agreement.

