

- UNI-CAST
- MULTI-CAST
- DURA-CAST
- ULTRA-CAST

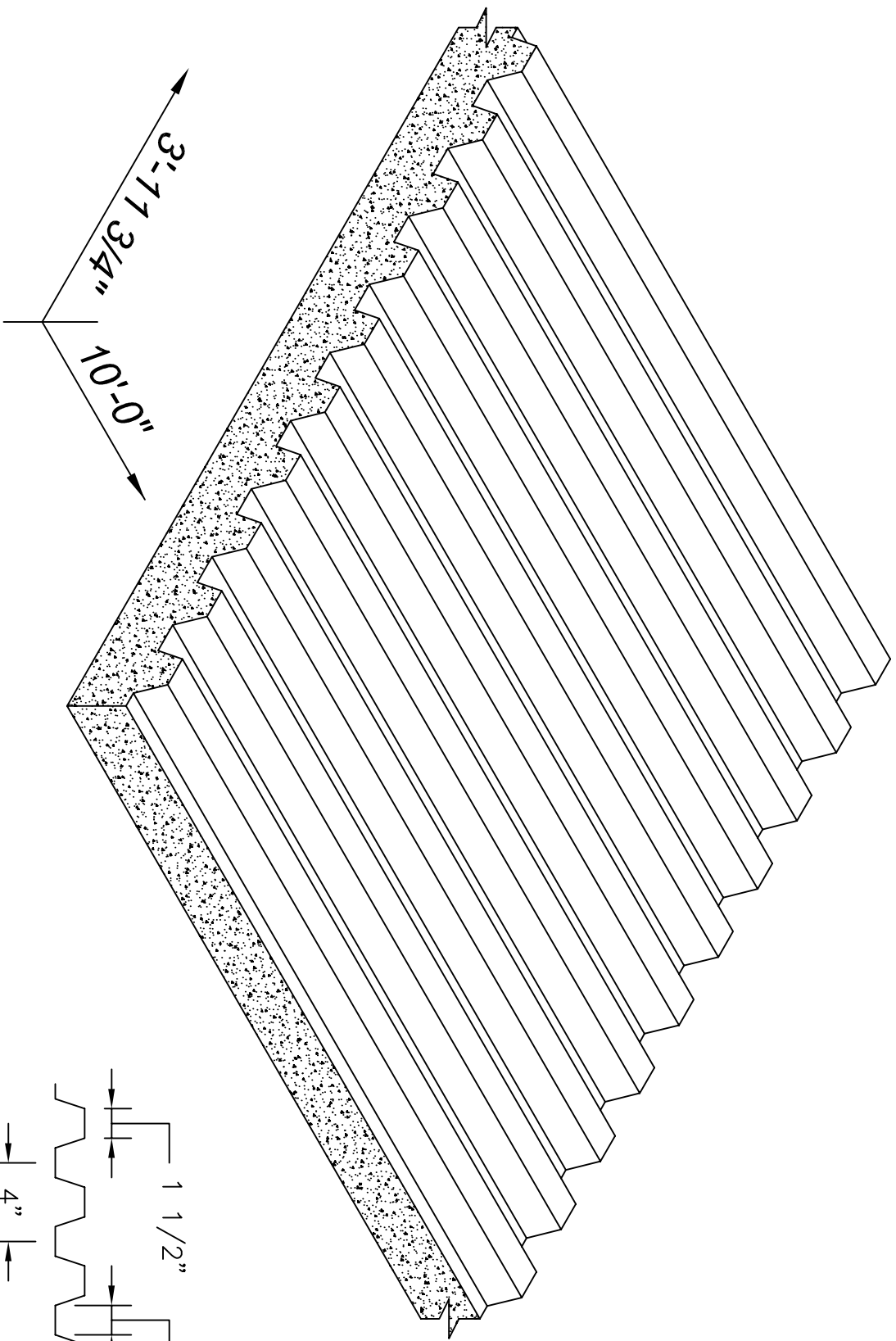

ISOMETRIC VIEW

SCALE: NOT TO SCALE

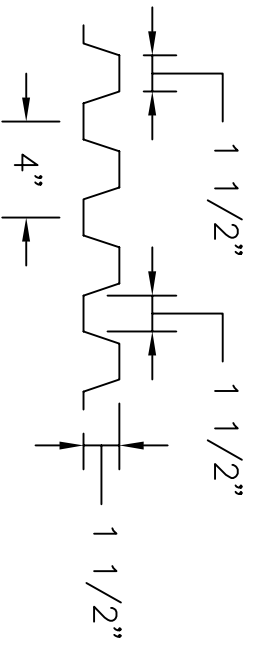

SECTION VIEW

SCALE: 1-1/2" = 1'-0"



REV. MARK	REVISION	BY	CHK	APP	DATE	DESIGNED:	DATE:
						DRAWN:	PART NUMBER:
						CHECKED:	QUANTITY REQUIRED:
						APPROVED:	SCALE: AS SHOWN
						MFG. REP.:	DWG. REF. NO.:
						SHEET NUMBER:	GSK302

3400 TREE CRT. IND. BLVD.,		ST. LOUIS, MO	63122-6689
PH: 800-325-9504 (636-225-9400)		FX: 800-551-5145 (636-225-2049)	
WEBSITE: www.greenstreak.com		EMAIL: info@greenstreak.com	
TITLE: #302 TRAPEZOIDAL RIB			REV